

PLACER LES RESISTANCES 75 OHMS ENTRE  
A et 1  
B et 1  
SUR LE DERNIER  
REPARTITEUR

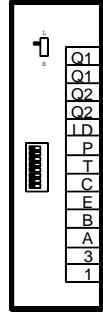

MONITEUR T-LINE  
AV1423/001 et  
AV1423/010



AV1423/001 & AV1423/010  
OU :  
AV1423/002 & AV1423/010

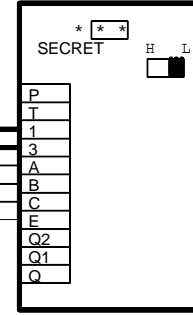

MONITEUR  
MV100/MVC100  
AN8419/AN8401

MONITEUR MV 3000/AV6000  
MVC 3000/AV 6018

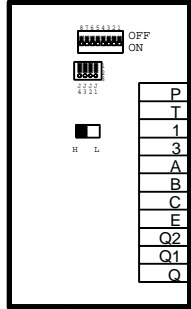

Position des cavaliers et du DIP switch :  
Voir mode d'emploi.

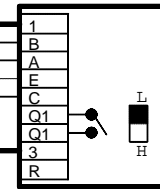

MONITEUR VIDEO  
AN8310

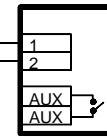

COMBINE  
AN0036/AN9136

COMBINE  
SUPPLEMENTAIRE  
OPTIONNEL

### RECOMMANDATIONS

- LES ENTREES 1, 3, A, B DES REPARTITEURS VIDEO SONT A CABLER EN PARALLELE.
- LES FILS A et B DOIVENT ETRE PRIS SUR LA MEME PAIRE.
- UTILISER UNE SORTIE VIDEO PAR MONITEUR
- PLACER LES RESISTANCES DE 75 OHMS EN BOUT DE COLONNE
- PLACER L' ALIMENTATION A 20 M MAX. DE LA PLATINE DE RUE.

ALIMENTATION AN7361

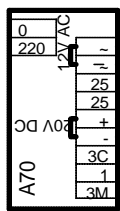

### Domular Evolution

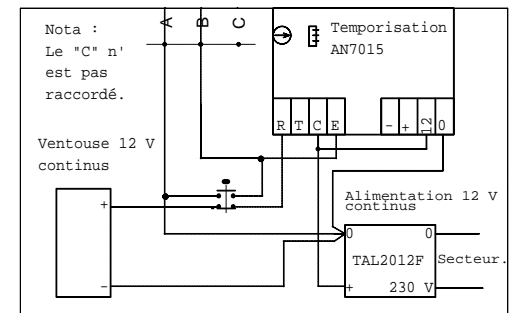
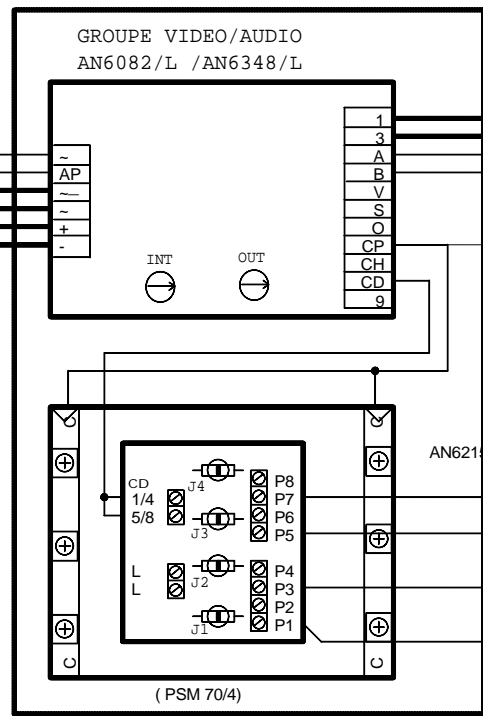

Système GACHE à RUPTURE et VENTOUSE

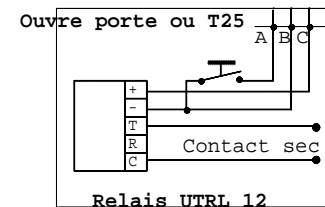

Relais UTRL 12

Ouvre porte ou T25

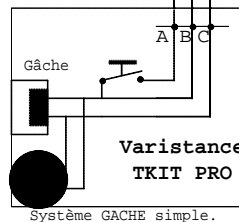

Système GACHE simple.

### TABLEAU DES SECTIONS

DISTANCE	FIL: 1/3/+/-	FIL: A/B	FIL: C/E/T/O	FIL: AP GACHE
50M	1mm2	0.35mm2	0.5mm2	1mm2
100M	1.5mm2	0.35mm2	0.8mm2	
200M	2.5mm2	0.35mm2	1mm2	



EVICOM-BITRON

Tel:04.93.44.70.71 Fax:04.93.44.99.60

Title Domular Evolution vidéo  
N BP ET N MONITEURS AVEC AN7361  
Size Document Number SCA-60-489  
Custpm  
Date: Tuesday, December 04, 2007 Sheet 1 of 1