

SCA-51-146

PLATINE UHR XXX

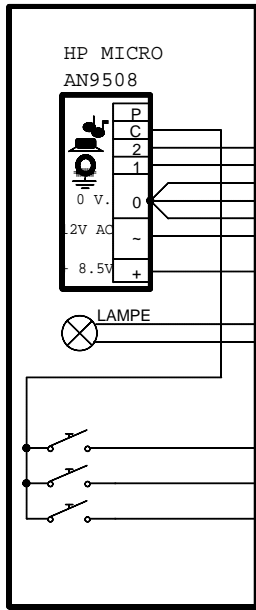

COMBINE AN9110
AV1407/003

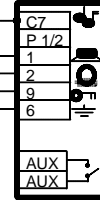

COMBINE AN9110
AV1407/003

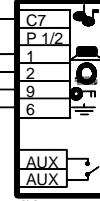

COMBINE AN9110
AV1407/003

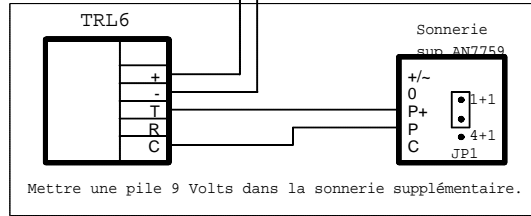
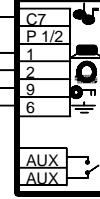

ALIMENTATION
AV1142

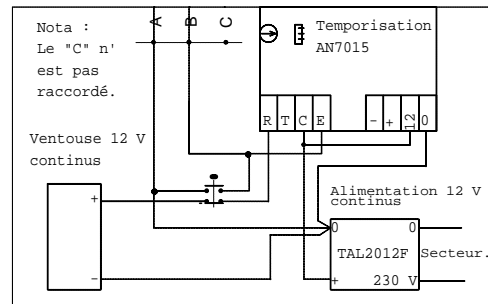
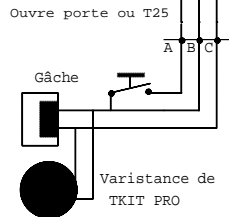
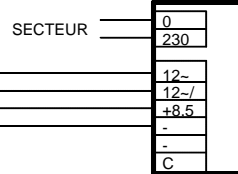

Système GACHE à RUPTURE et VENTOUSE

PLATINE "HAUT RISQUE" OU "INOX"

bitron VIDEO EVICOM-BITRON
Tel:04.93.44.70.71 Fax:04.93.44.99.60

Title INSTALLATION 5 FILS APPEL ELECTRONIQUE

Size A4 Document Number SCA-51-146 Rev

Date: Friday, July 13, 2007 Sheet 1 of 1

Diamètre et section des conducteurs

Distance	1-2-11		6-9	
	Dia.	Sec.	Dia.	Sec.
50 mt	0.6	0.3	0.8	0.5
100 mt	0.8	0.5	1.0	0.8
200 mt	1.0	0.8	1.2	1.0

Ouvre porte ou T25

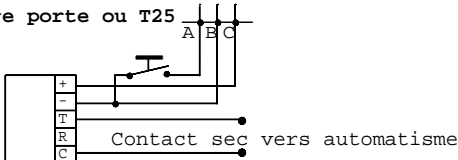

Relais UTRL 12