

Tableau section			
Distance	Fils : 1 / 2	Fils B+ et B-	Fils : AP / ~ (Gâche) / ~0 / ~12
50M	1mm ²	9/10ème	1mm ²
100M	1.5mm ²		
200M	2.5mm ²		

Platine
G TO 2002V/C

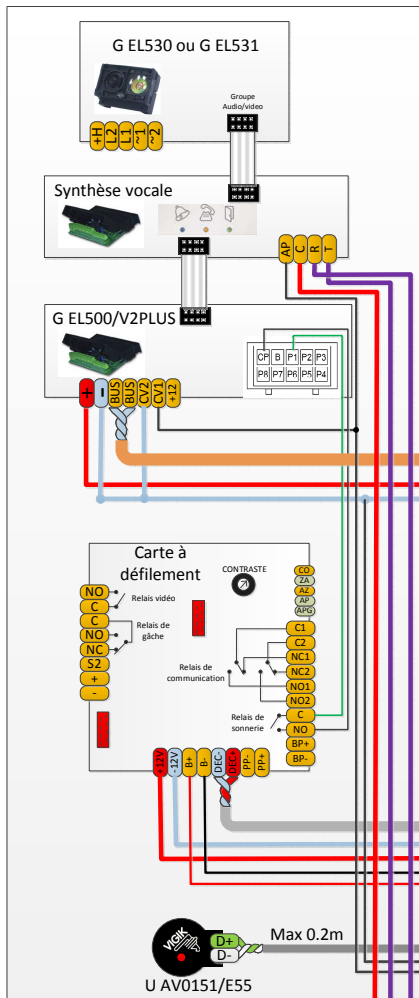

Câble G RA2150
paire torsadée

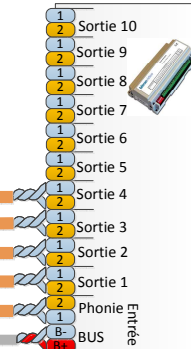
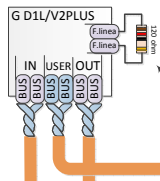

Adresse du décodeur à paramétrer
Résistance de 120 ohm à placer sur le dernier D1L/V2PLUS

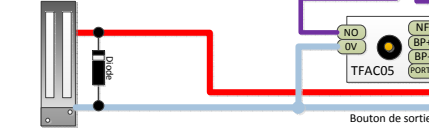
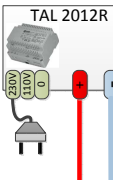
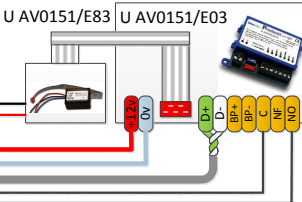
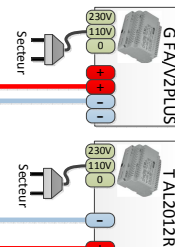

Ventouses ou gâche à rupture

